

HURRICANE

安裝說明手冊
MANUAL

組裝教學 Installation Video
<https://youtu.be/eH05C2cmGR4>





Thanks for buying Ducky Hurricane.
Please read this manual carefully before installation
and follow the instructions.

感謝您購買 Ducky Hurricane，
請於安裝前詳閱安裝說明手冊，
並遵循安裝說明手冊上步驟小心安裝。

NOTES 注意

1. Max. Loaded Weight: 136 kg, 155~195 cm is fitted.
椅子最大限重: 136kg，適用於155~195cm身材。
2. Please avoid the fire, direct sunlight and wet environment.
請遠離火源、並請勿放置於陽光直射或是潮濕的環境。
3. Please do not put the chair on a high or unstable place in case of falling down.
請勿把椅子放至於高處，或不平坦處，避免椅子傾倒。
4. Please put the chair on a flat ground.
請將椅子放置於平面且平坦處。
5. Please pay attention to your kids when they are climbing the chair.
請注意，勿讓兒童或幼兒攀爬至椅子上，以免造成危險。
6. Please pay attention to the natural loosen of the bolts after long-term using, avoiding shaking roughly when sitting.
長時間使用後，或購買一段時間，適時注意並檢視螺絲是否有鬆動，且避免於乘坐時劇烈搖晃。
7. Please avoid excessive tilt using in case of falling down.
請避免乘坐時過度傾斜，造成椅子傾倒。

產品尺寸 Dimension

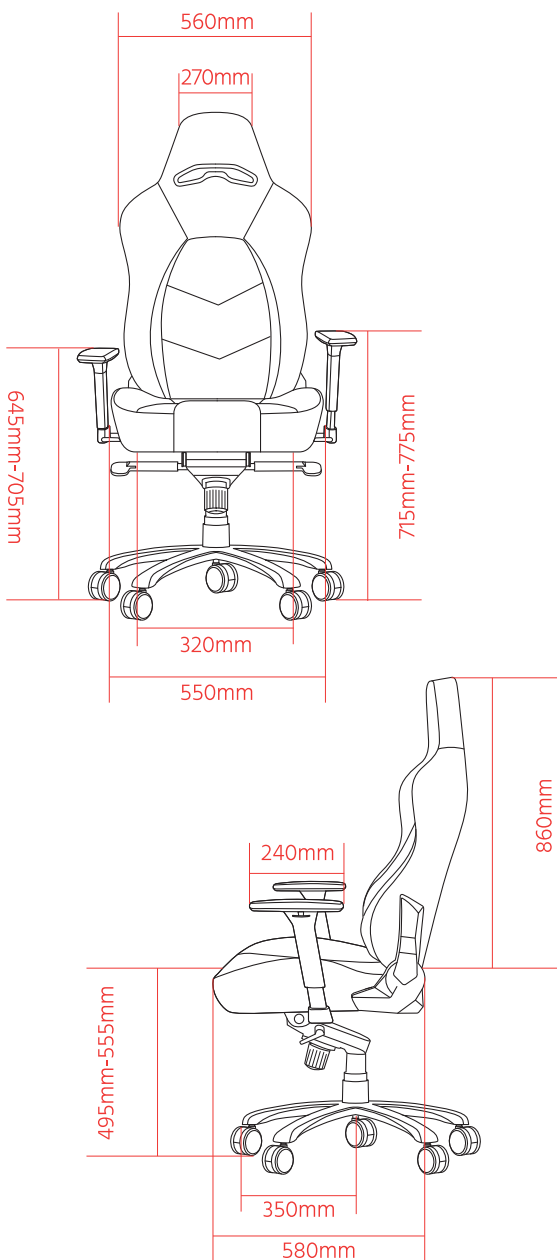

產品配件

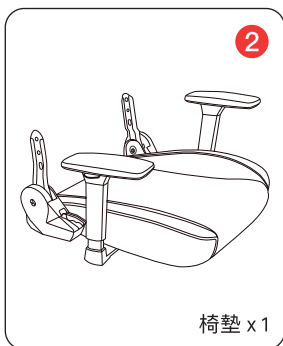
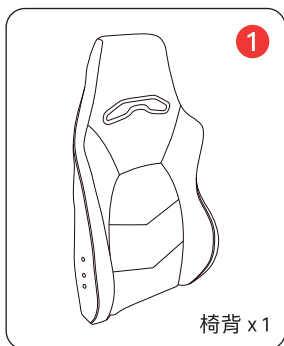
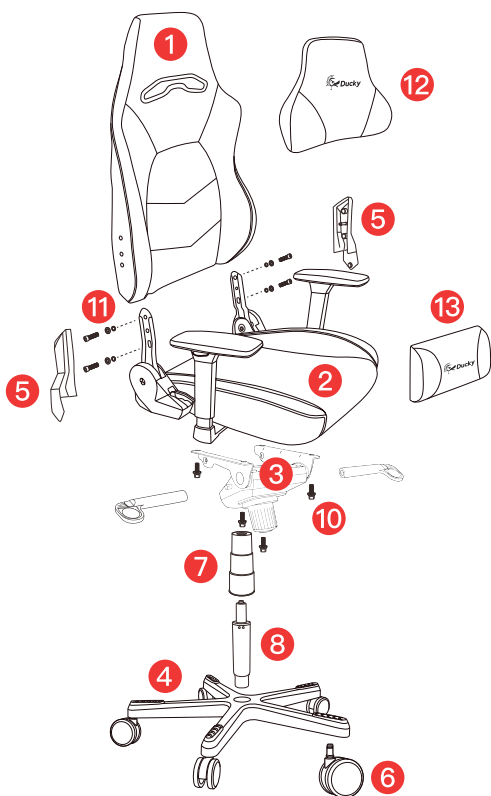

產品配件

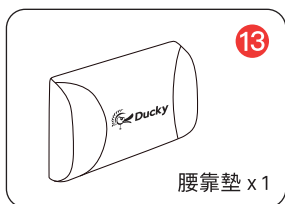
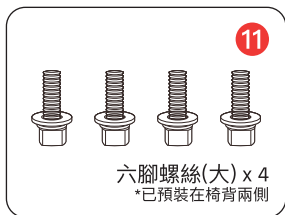
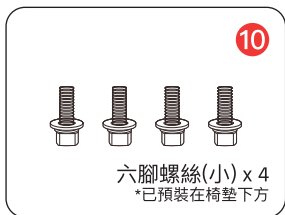
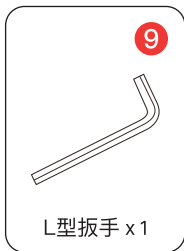
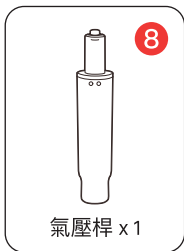
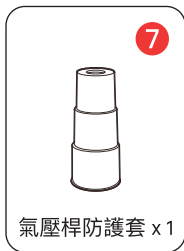
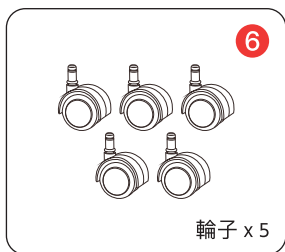
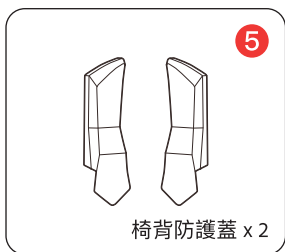
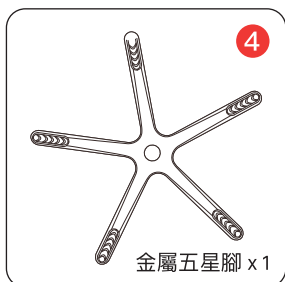

安裝步驟

步驟 1

準備安裝椅背與椅墊

請先將椅背左右兩側上預裝的螺絲取下，共四顆。然後將椅背與椅墊放置一起。並注意紅圈處，將椅背的螺絲孔與椅墊上的螺絲孔對齊（左側與右側）。



步驟 2

安裝椅背與椅墊

參照右圖，依序將左右四顆螺絲鎖上並固定。請從右側開始將螺絲鎖上（此時螺絲勿鎖緊），接著將左側兩顆螺絲鎖上（此時螺絲勿鎖緊），待四顆螺絲皆鎖上後再將四顆螺絲鎖緊。



步驟 3

安裝椅背防護蓋

先將防護蓋下方裝入卡榫，待下方卡榫安裝好後，再將防護蓋上方卡榫裝至定位。安裝過程中需要施加點壓力才能裝入。

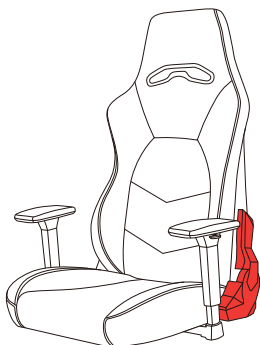
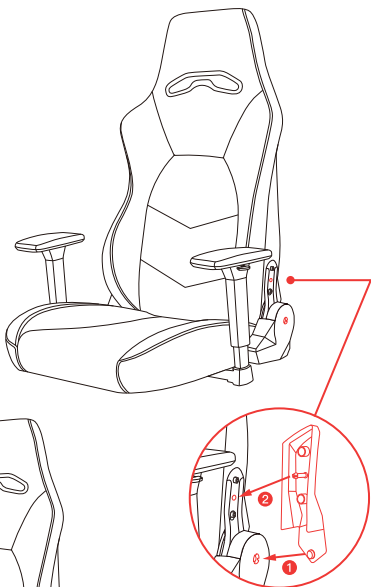

步驟 4

安裝托盤

請先將椅墊下方預裝的螺絲取下，共四顆。然後將托盤與椅墊的螺絲孔對齊後，鎖上四顆螺絲，並於鎖定後安裝調整手柄。

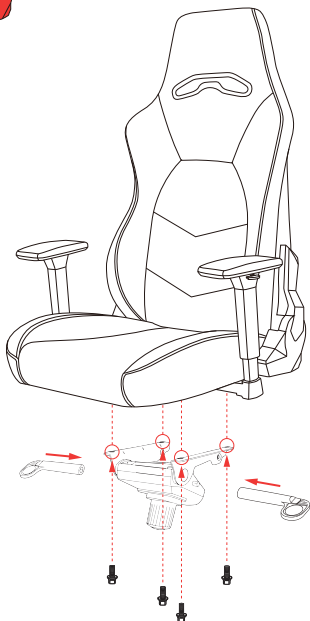

安裝步驟

步驟 5

安裝輪子

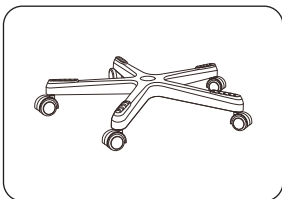
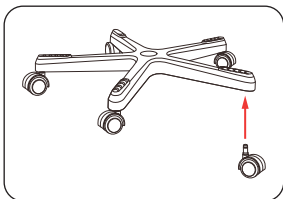

步驟 6

安裝氣壓桿

裝上氣壓桿後，將氣壓桿上方的黑色安全蓋取下。

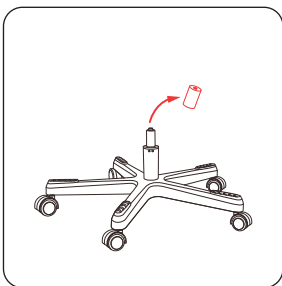
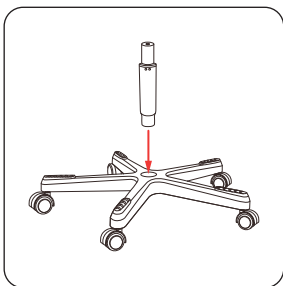

步驟 7

將氣壓桿保護套套上

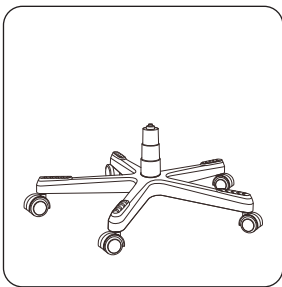
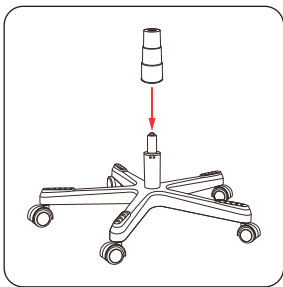

步驟 8

將椅身與氣壓桿結合

將托盤上的圓孔對準氣壓桿，然後將椅身裝上。

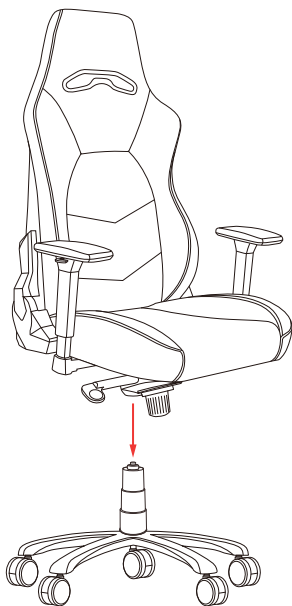

功能操作

托盤下方黑色圓型旋轉開關：調整傾斜鬆緊度

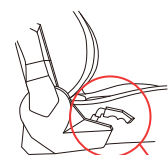

椅子右方手柄：
調整椅子傾斜
角度

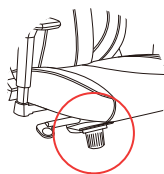

右方調節手柄：
升降高度

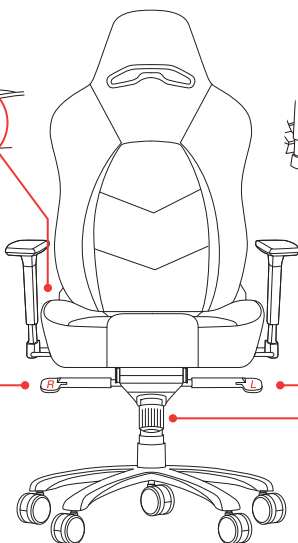

左方調節手柄：
鎖定椅子傾斜
功能

Spare Parts

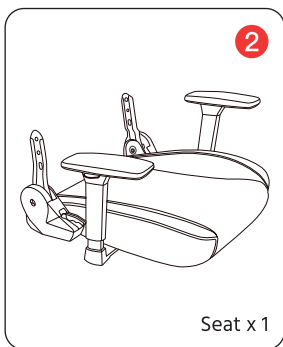
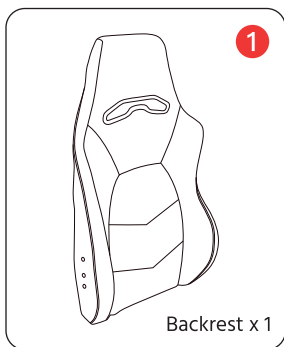
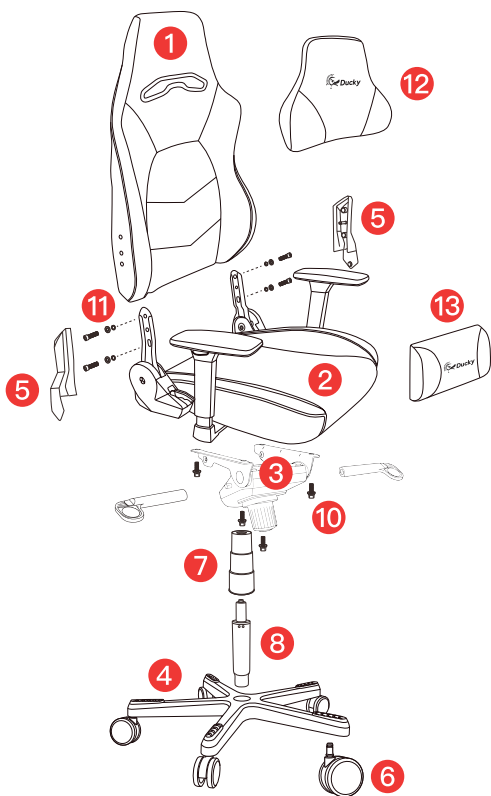

Spare Parts

3



Mechanism x 1

4

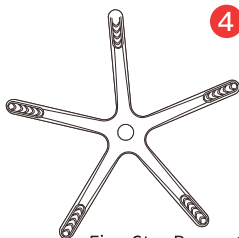

Five Star Base x 1

5

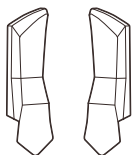

Recliner Cover x 2

6

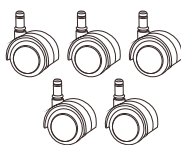

Wheel x 5

7

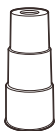

Gas Spring Cover x 1

8



Gas Spring x 1

9

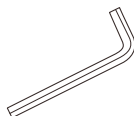

L Shape Wrench x 1

10

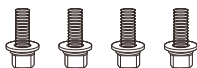

Hexagonal Socket Bolts (Small) x 4
*Pre-mounted under the seat

11

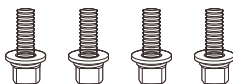

Hexagonal Socket Bolts (Big) x 4
*Pre-mounted on the left and right side of the backrest

12



Headrest x 1

13

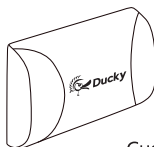

Cushion x 1

Installation Process

STEP 1

Put the backrest and the seat together

Please remove the bolts that are pre-mounted on the backrest; two bolts are located on each side of the backrest. Then place the backrest on the seat. Put the backrest on the seat together as the picture. Please pay attention to the red marked place (left and right sides) which is needed to aim at the bolts holes.



STEP 2

Lock the backrest and the seat

Lock the 4 bolts on the left and right side as the picture step by step. Begin at the right side where the tilting handle is located. Screw both bolts on the right side half way in and then screw in the two bolts on the left side. Now tighten the bolts on both sides.

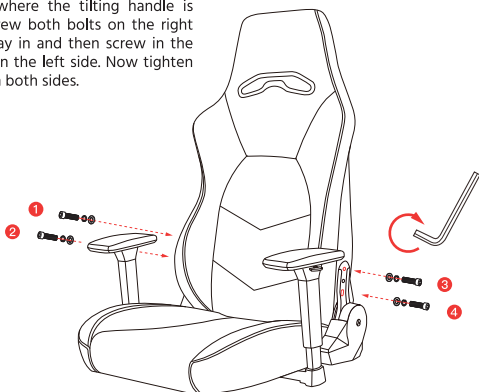

STEP 3

Install the recliner covers

Attach the lower snap button first, then the upper snap button. You need to apply some pressure in order to make sure it is installed properly.

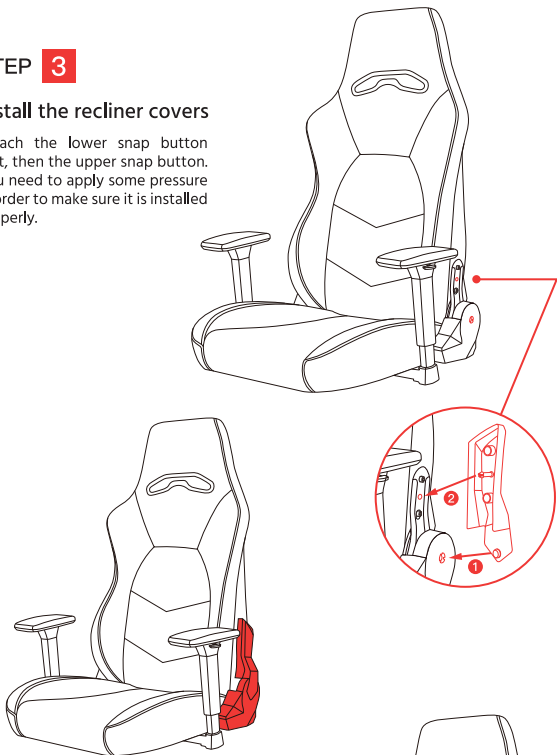

STEP 4

Install the mechanism

Please remove the bolts that are pre-mounted on the seat; 4 bolts are located on button side of the seat. Use the bolts to lock the mechanism and seat together, and make sure the bolts are screwed in tightly. Install the handles at last.

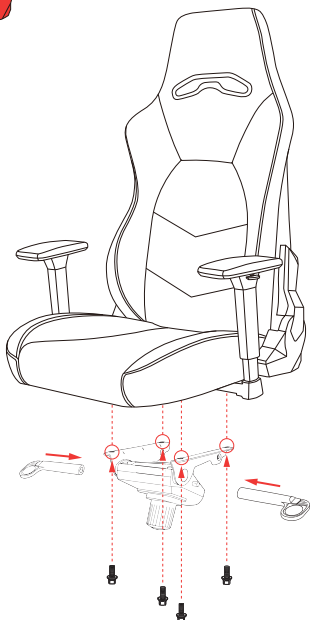

Installation Process

STEP 5

Install the wheel

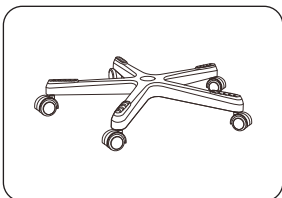
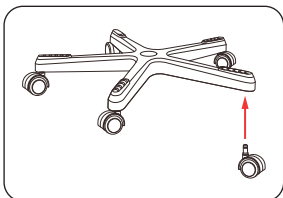

STEP 6

Install the gas spring

After installing the gas spring, remove the black cover.

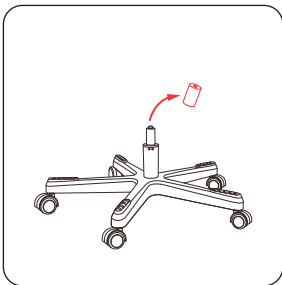
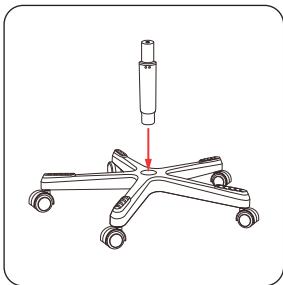

STEP 7

Put on the gas spring cover

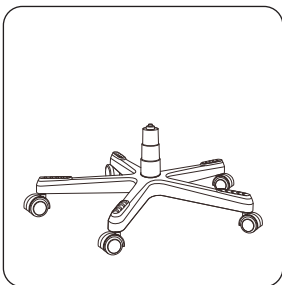
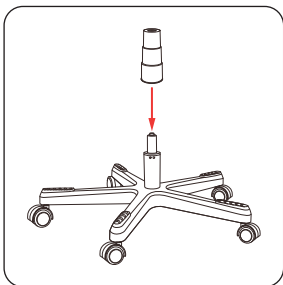

STEP 8

Put the chair body on the gas spring

Aim at the top of gas spring and the hole of mechanism, and then put the chair body down.

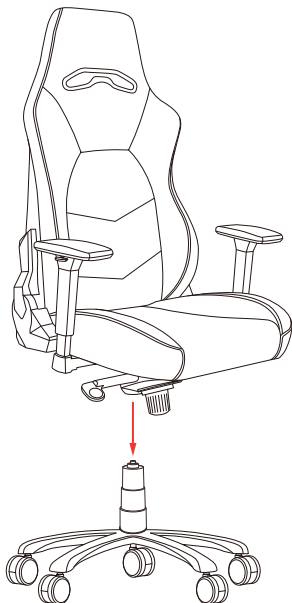

Operating Instructions

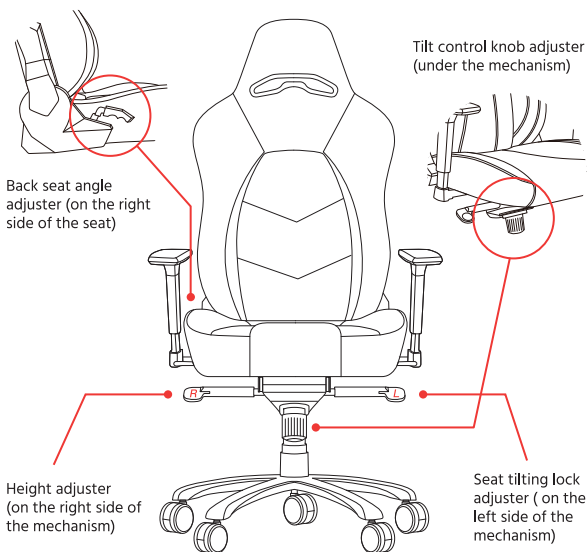



www.duckychannel.com.tw

客服信箱 Mail: support@duckychannel.com.tw

客服聯絡電話 TEL: (02)2797-6288#33